

Padangos ir ratų komplektai karučiams ir smulkiajai sodo technikai

Kameros, ventiliai, ratlankiai



BENDROVĖ STARCO – GAMINTOJA
IR OFICIALI ĮMONIŲ ATSTOVĖ

STARCO

KENDA

DEESTONE

Deli Tire



Nepraduriami ratai karučiams ir vežimėliams STARCO FLEX lite su universalia stebule



Dydis	Protektorius	57 07562+	Rato spalva	C mm	D mm	
8,5"						
26-8.5E (3.00-4)	STARCO FLEX lite ST-18 Yellow	372143	Black	45	35	0=0
10"						
34-10E (3.50-6)	STARCO FLEX lite ST-18 Yellow	359113	Black	71	35	0=0
12"						
39-12E (4.00-8)	STARCO FLEX lite ST-18 Yellow	359052	Black	71	35	0=0



Pilnai sukomplektuotą ratą sudaro STARCO FLEX lite ir įvorių kompleksas.



**STARCO FLEX –
pamirškite pradurtas
ir nuleistas padangas!**

**Pagaminta
STARCO**

**Pamirškite pradurtas ir nuleistas padangas!
Jums nebereikės vargti, kad prisimintumėte,
kur praėjusį rudenį padėjote pompą.**



Siūlome pasižiūrėti filmuką apie STARCO Flex Lite

Įmonė STARCO pristato inovacinę nepraduriamų ratų seriją STARCO FLEX su poliuretalinėmis padangomis, sukurtą STARCO konstruktorių skyriaus ir gaminamą Didžiojoje Britanijoje veikiančioje nuosavoje įmonės gamykloje.

Pagal eksploatacines savybes ratai STARCO FLEX nenusileidžia tradiciniams pneumatiniams ratams, yra universalūs, jų nereikia papildomai prižiūrėti.

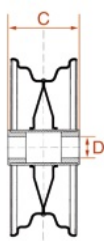

ST-18

Nepraduriami ratai karučiams ir vežimėliams STARCO FLEX iCore su universalia stebule



Dydis	Protektorius	57 07562+	Rato spalva	C mm	D mm	
12"						
39-12E (4.00-8)	STARCO FLEX iCore Yellow	507453	Black	71	35	0=0



Pagaminta
STARCO

STARCO FLEX iCore – modernūs nepraduriami ratai karučiams

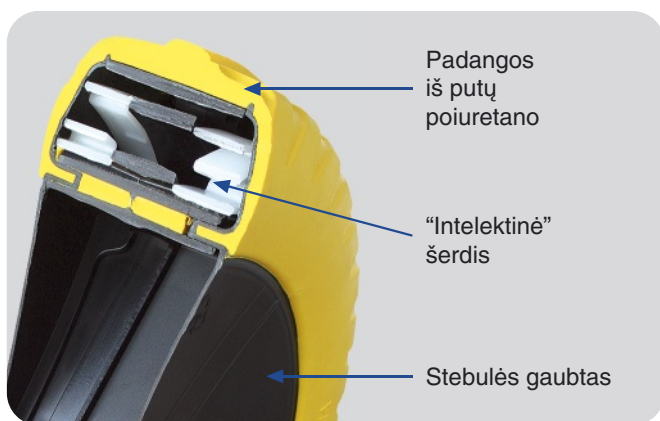

Ratai STARCO FLEX iCore sukurti glaudžiai bendradarbiaujant su žinomiausiais karučių gamintojais ir yra gaminami nuosavoje STARCO gamykloje, Didžiojoje Britanijoje.

STARCO FLEX iCore yra trečios nepraduriamų STARCO FLEX gaminių kartos produktas. Ratai STARCO FLEX iCore pasižymi geresnėmis amortizacinėmis savybėmis ir nedideliu pasipriešinimu riedėjimui.

STARCO FLEX iCore jungia du komponentus:

- ▶ Plastikinė „intelektinė“ šerdis suformuoja standų karkasą, prie kurio tvirtinami kiti komponentai, tarp jų universalioji stebulė. STARCO FLEX iCore rato intelektiškumas pasireiškia jo dizaine, kuris užtikrina rato mechaninį patvarumą ir tamprumą
- ▶ Elastingo putų poliuretano padangos, kurios dengia ne tik išorinę rato dalį, bet ir šerdį bei stebulės gaubtą vidinėje rato dalyje. Taigi, tokių ratų nereikia papildomai prižiūrėti, juos lengva valyti, o eigos tolygumo požiūriu šie ratai yra palygintini su pneumatiniiais



STARCO FLEX iCore

STARCO

Padangos karučiams ir vežimėliams

Pneumatinės padangos

Dydis	PR/LI	Protektorius	TL/TT	57 07562+	mm	mm	kg	km/h	bar	
3.75"										
200x50 (8x2)	2PR	Deli S-379 (padangos komplektas*)	DIN 7768 60/20	130675	194	48	75	16	1.80	1.25
4"										
3.00-4 (260x85 10x3)	2PR	DSI SRI/T-08	TL	129495	260	85	95	25	2.50	2.10
	4PR	Kenda K373 (padangos komplektas*)	TR13	282206	269	86	170	16	4.25	2.10
4.00-4	2PR	Kenda K373	TL	330969	304	104		16		2.25
	4PR	Kenda K373	TL	129754	304	104	245	16	4.25	2.25
6"										
3.50-6	2PR	Deli S-379	TL	129631	332	94	175	16	2.00	2.50
	4PR	Deli S-379 (padangos komplektas*)	TR13	129679	326	96	200	15	3.00	2.50
4.00-6	2PR	DSI SRI/WB-01	TL	129846	358	104	220	16	2.00	2.50
	4PR	Deestone D601 (padangos komplektas*)	TR13	129891	355	100	230	20	3.50	2.50
4.10/3.50-6	4PR	Kenda K304	TT	151175	315	86	200	16	3.50	2.50
8"										
2.25-8 (12 1/2x2 1/4)	2PR	Deestone D1006	TT	376691	325	65	40	15	2.50	1.75
4.80/4.00-8	2PR	STARCO WB-04	TL	337272	385	100	155	30	1.50	3.00
	4PR	STARCO WB-04 (padangos komplektas*)	TR13	129990	399	102	305	16	4.25	2.50

* Padangos komplektas = padanga + kamera



Universalūs STARCO ratų sprendimai

- ▶ Ratų ir įvorių kombinacijų įvairovė skirta patenkinti beveik visus poreikius, susijusius su ratais, skirtais karučiams, vežimėliams ir kitoms panašioms priemonėms
- ▶ Aukštos kokybės ratai su plastikiniais arba plieniniais ratlankiais – tai patikimas sprendimas
- ▶ Sukurta ir pagaminta STARCO
- ▶ Šiuos ratus žinomiausi šio segmento gamintojai montuoja pirmajame – gamykliniame – savo produkcijos komplekte

Deli Tire **KENDA** **DEESTONE** **STARCO**



DSI SRI/WB-01 / Deestone D601 / Deli S-379

Kenda K304

DSI SRI/T-08 / Kenda K373

STARCO WB-04

Deestone D1006

Ratų karučiams ir vežimėliams komplektai

Su pneumatinėmis padangomis ir plastikiniais ratlankiais



Dydis	PR/LI	Protektorius	57 07562+	Ratlankio tipas ir dydis	C mm	D mm	
3.75"							
200x50	2PR	ST-11	492438	GR 1.25x3.75	59	20	==
4"							
3.00-4 (260x85)	2PR	ST-28	392608	GO 2.25Ax4	71	35	0-0
	2PR	ST-28	365626	GR 2.25Ax4	75	20	==
	2PR	ST-28	492469	GO 2.25Ax4	75	20	0-0
4.00-4	4PR	ST-28	182841	GO 2.25Ax4	71	35	0-0
	4PR	ST-28	492476	GR 2.25Ax4	75	20	==
	4PR	ST-28	492483	GO 2.25Ax4	75	20	0-0
6"							
3.50-6	2PR	ST-11	453484	GO 2.50Ax6	94	16	0-0
	2PR	ST-11	392653	GO 2.50Ax6	71	35	0-0
	2PR	ST-11	492490	GR 2.50Ax6	75	20	==
	2PR	ST-11	492506	GO 2.50Ax6	70	25	0-0
4.00-6	2PR	ST-11	492445	GO 2.50Ax6	71	35	0-0
	2PR	ST-11	492513	GR 2.50Ax6	75	20	==
	2PR	ST-11	492520	GO 2.50Ax6	75	20	0-0
8"							
4.00-8	2PR	ST-15	492452	GO 2.50Ax8	71	35	0-0
	2PR	ST-15	492544	GR 2.50Ax8	75	20	==
	2PR	ST-15	492551	GO 2.50Ax8	75	20	0-0

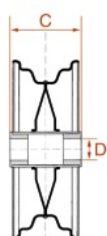

GO

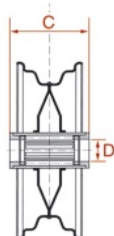

GR



Ivorės
(slydimo
guolis)

0-0



Adatinis
guolis

==



Rutulinis
guolis

8=8



ST-11



ST-15



ST-28

STARCO

Plastikiniai ratlankiai

Su universalia įtaisyta stebule

Dydis	C mm	D mm		Rato spalva	57 07562+
3.75"					
GR 200x50	54	35	0=0	Black	169538
4"					
GO 2.25Ax4 H2	71	35	0=0	Red	336398
6"					
GO 2.50Ax6 H2	94	16	0=0	Red	311852
GO 2.50Ax6	71	35	0=0	Red	169965
8"					
GO 2.50Ax8 H2	71	35	0=0	Red	298832



Universalūs plastikiniai ratlankiai su įtaisyta stebule ir įvorių komplektas sudaro integruotą ratą. Dabar teliko išsirinkti reikiamą padagą (žr. 4 psl.) ir ratas bus baigtas komplektuoti!

Plastikiniai ratlankiai gaminami nuosavoje STARCO gamykloje Didžiojoje Britanijoje.

Įvorės ir guoliai

Ratlankiams su universalia stebule

Dydis	C mm	D mm		57 07562+
Adatinis guolis				
20x35x55 mm	75	20	==	164656
Guolio dangtelis				
20x75 mm	75	20	==	164465
Įvorės (slydimo guolis)				
20x35x73 mm	73	20	0-0	164144

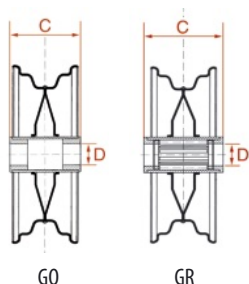

0-0



Adatinis guolis

==



Rutulinis guolis

8=8



Pagaminta
STARCO

Sukomplektuoti ratai, skirti karučiams ir vežimėliams

Su pneumatinėmis padangomis ir plieniniais ratlankiais

Dydis	PR/LI	Protektorius	TL/TT	57 07562+	Rato spalva	C mm	D mm		
4"									
3.00-4	4PR	ST-28	TL	091699	GK 2.10x4	Red	100	20	==
4.00-4	4PR	ST-28	TL	091701	GK 2.10x4	Red	100	20	==
6"									
3.50-6	2PR	ST-11	TL	492421	GK 2.50x6	Red	100	20	8-8
4.00-6	4PR	ST-11	TL	091722	GK 2.50x6	Red	100	20	8-8
15x6.00-6	4PR	ST-50	TR13	091768	GK 4.50Ax6	Grey	90	25	8-8
8"									
4.00-8	4PR	ST-15	TR13	091740	GK 2.50x8	Red	100	20	==
	4PR	ST-15	TR13	091736	GK 2.50x8	Red	110	25	==

Plieniniai ratlankiai gaminami nuosavoje STARCO gamykloje Kroatijoje naudojant pažangiausias suvirinimo technologijas. Visai produkcijai apdoroti taikomi pradinio valymo, padengimo elektroforezine danga ir miltelinio dažymo procesai. Veiksminga kokybės kontrolės sistema leidžia įmonei STARCO garantuoti gamybinių defektų nebuvimą.



Plieniniai ratlankiai

Su įtaisyta stebule

Dydis	C mm	D mm	Rato spalva	57 07562+
4"				
GK 2.10x4	100	20	==	277523
6"				
GK 2.50Ax6	100	20	8-8	277448
GK 4.50Ax6 H2	90	25	8-8	316215
8"				
GK 2.50Ax8	100	20	==	275215
GK 2.50x8	110	25	==	168401



ST-11

ST-15

ST-28

ST-50

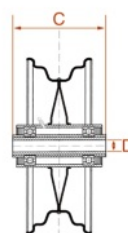

GK

Padangos smulkiajai sodo technikai

Padangos vejai



Dydis	PR/LI	Protektorius	TL/TT	57 07562+	mm	mm	kg	km/h	bar	
4"										
9x3.50-4	4PR	Kenda K372	TL	330464	229	94	105	16	3.50	2.10
6"										
13x5.00-6	4PR	Kenda K500 Super Turf	TL	128191	322	122	200	16	2.75	3.50
15x6.00-6	4PR	Deli S-365 (padangos komplektas*)	TR13	130514	364	151	260	16	2.10	4.50
	4PR	Kenda K500 Super Turf	TL	128238	374	158	259	16	2.10	4.50
	4PR	Kenda K401H	TL	280776	358	154	260	16	2.10	4.50
8"										
16x6.50-8	4PR	Kenda K500 Super Turf	TL	128276	400	178	280	16	1.90	5.375I
	10PR	Kenda K401H (padangos komplektas*)	TR13	330303	398	167	485	16	4.90	5.375
18x7.50-8	4PR	Kenda K500 Super Turf	TL	128399	458	192	360	16	1.70	5.375I
18x8.50-8	4PR	Deli S-317 (padangos komplektas*)	TR13	330495	444	216	370	16	1.50	7.00
	6PR	Kenda K500 Super Turf	TL	128467	452	217	475	16	2.40	7.00I
18x9.50-8	4PR	Kenda K500 Super Turf	TL	128504	462	236	470	16	1.70	7.00I
20x10.00-8	6PR	Kenda K500 Super Turf	TL	278513	504	261	700	16	2.30	8.00
190-8	8PR	Kenda K383 Power Turf	TL	153223	420	185	575	25	5.90	5.50A
10"										
20x10.00-10	4PR	Kenda K500 Super Turf	TL	151076	501	246	495	20	1.50	8.00
12"										
23x8.50-12	10PR	Kenda K500 Super Turf	TL	151069	570	219	1080	16	5.50	7.00
23x10.50-12	4PR	Kenda K500 Super Turf	TL	129006	580	264	549	30	1.40	8.50
24x13.00-12	6PR	Kenda K507	TL	279794	610	333	1015	16	1.90	10.50
26x12.00-12	8PR	Kenda K500 Super Turf	TL	129440	669	321	1385	16	3.40	10.50

* Padangos komplektas = padanga + kamera

KENDA K500 SUPER TURF

- ▶ Profesionalios padangos vejapjovėms
- ▶ Šias padangas naudoja žinomiausi Amerikos vejapjovių gamintojai
- ▶ Išskirtinis atsparumas nusidėvėjimui ir pradūrimui
- ▶ Didesnis protektoriaus gylis
- ▶ Didelė kontaktinė dėmė
- ▶ Užapvalinta padangos briaunelė leidžia ženkliai sumažinti vejos apgadinimą



Kenda K372/ Deli S-365



Kenda K383 Power Turf



Kenda K401H/ Deli S-317



Kenda K500 Super Turf



Kenda K507

Padangos smulkiajai sodo technikai

Greituminės padangos smulkiajai technikai ir priekaboms



Dydis	LI/SI/PR	Protektorius	TL/TT	57 07562+	mm	mm	kg	km/h	bar	
8"										
4.00-8	71M (8PR)	Kenda K385	TT	329222	405	122	345	130	6.20	3.75
4.80/4.00-8	62M (4PR)	Deli S-380	TL	129952	408	118	265	130	4.25	2.50 E
5.70/5.00-8	77M (6PR)	Deli S-378	TL	130965	465	140	412	130	5.20	3.75 E
16.5x6.50-8	72M (6PR)	Deli S-368	TL	128283	406	165	355	130	4.90	5.375 E
18.5x8.50-8	78M (6PR)	Deli S-368	TL	128450	462	220	425	130	3.50	7.00 E
9"										
6.00-9	85M (6PR)	Deli S-252	TT	131108	528	158	515	130	4.10	4.00
10"										
4.00-10	63M (4PR)	Deli S-252	TL	192154	458	106	272	130	3.00	3.00
5.00-10	72M (4PR)	Deli S-252	TL	131016	525	141	355	130	3.50	3.50 E
145/80B10	74N (4PR)	STARCO S 255	TL	259468	495	135	375	140	2.50	3.50
195/50B10	98N (8PR)	Kenda K399 Load Star	TL	128405	460	185	750	140	6.00	6.00 E
195/55R10C	98/96P	GT ST-5000 M+S	TL	151120	466	190	750	140	6.20	6
20.5x8.0-10	95M (10PR)	Deestone D268	TL	327464	538	205	690	130	6.20	6.00
205/65-10	98N (10PR)	Kenda K399 Load Star	TL	128665	520	213	750	140	6.20	6.00 E
12"										
155/70R12C	104/101N	Kenda Kargo Pro	TL	269016	523	152	900	140	6.50	4
225/55B12	112N (10PR)	Kenda K399 Load Star	TL	128962	554	225	1120	140	7.00	7.00I
13"										
195/50R13C	104/101N	Kenda Kargo Pro	TL	269047	526	201	900	140	6.50	6.00

Deli Tire **KENDA** **DEESTONE** **STARCO**



Kenda K385



Kenda K399 Load Star



Kenda Kargo Pro



GT ST-5000



Deli S-252/ Deli S-378



Deli S-255



Deli S-368/ Deestone D268



Deli S-380

Ratlankiai sulkiajai sodo technika ir priekaboms

Plieniniai ratlankiai

Dydis	ET mm	Rato spalva	57 07562+	kg	km/h
8"					
5.50Ax8 H2	4/60/100	Ø14.5 60°	0	Silver	294384
7.00Ax8 H2	4/60/100	Ø14.5 60°	0	Silver	294414
10"					
6.00lx10 H2	4/60/100	Ø16 R12	-4	Silver	276540
	5/94/140	Ø18.5 R14	-4	Silver	277004
12"					
7.00lx12 H2	5/94/140	Ø18.5 R14	0	Silver	276441
10.50x12	5/94/140	Ø18.5 R14	0	Silver	139623

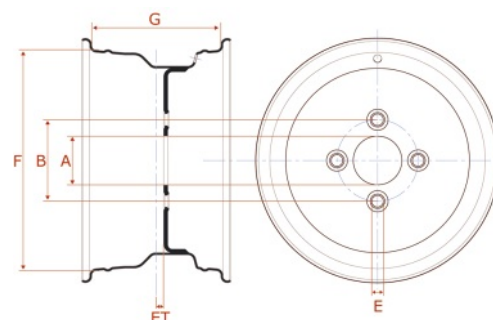

Ventiliai



	TR 412	TR 413 V2-03-1
A mm	19	19
B mm	14,5	14,5
C mm	21,5	29

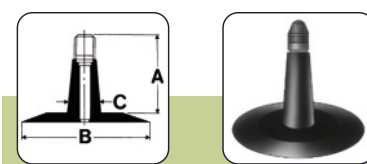

	TR 13 V2-01-1 • 38 G 11.5
A mm	35
B mm	56
C mm	11,5

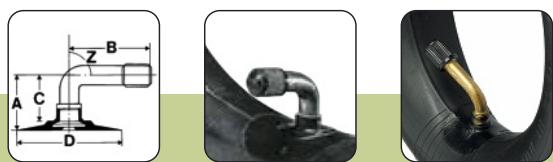

	TR 87 V1-08-1 • 33 G 90	DIN-7768 60/20
A mm	19	19
B mm	33	33
C mm	15	14,5
D mm	44,5	25
Z	90°	60°

STARCO

Kameros



Dydis	Ventilis	57 07562+		Padangų modeliui
200x50	DIN 7768 60/20	126661	100	200x50 • 8x2
4"				
3.00-4	TR13	127415	50	3.00-4 • 10x3 • 260x85
6"				
3.50-6	TR13	127569	50	3.50-6 • 4.00-6 • 4.10-6
13x5.00-6	TR13	154114	50	13x5.00-6 • 13x6.00-6 • 145/70-6
15x6.00-6	TR13	154176	50	15x6.00-6 • 140-6 • 15x5.50-6
8"				
2.50-8	TR13	154732	50	2.50-8 • 2.75-8 • 3.00-8
4.00-8	TR13	127644	50	4.00-8 • 16x4 • 3.50-8 • 400x100
5.00-8	TR13	127729	35	5.00-8 • 5.70-8
12 1/2x2 1/4	TR87	126371	100	12 1/2x2 1/4 • 12 1/2x1.75 • 12 1/2x1.90 • 2.25-8
16x6.50-8	TR13	153155	35	16x6.50-8 • 16x7.50-8 • 18x6.50-8 • 190-8
18x8.50-8	TR13	154190	30	18x8.50-8 • 18x11.00-8 • 18x7.00-8 • 18x7.50-8 • 18x9.50-8
20x8.00-8	TR13	153162	22	20x8.00-8 • 20x10.00-8 • 20x7.00-8
9"				
6.00-9	TR13	127804	30	6.00-9 • 6.90-9
10"				
3.00-10	TR13	154138	50	3.00-10 • 3.50-10 • 4.00-10
	TR87	154145	50	3.00-10 • 3.50-10 • 4.00-10
4.50-10	TR13	154329	45	4.50-10 • 5.00-10
20x8.00-10	TR13	126784	30	20x8.00-10 • 20x10.00-10
12"				
4.00-12	TR13	127675	40	4.00-12 • 4.50-12
23x8.50-12	TR13	154718	20	23x8.50-12 • 23x10.00-12 • 23x10.50-12 • 23x9.50-12 • 24x10.50-12 • 24x8.50-12
25x8.00-12	TR13	151151	20	25x8.00-12 • 25x10.00-12
26x12.00-12	TR13	127293	15	26x12.00-12 • 26.5x14.00-12 • 26x14.00-12
27x8.50-12	TR13	154220	15	27x8.50-12 • 27x10.00-12 • 27x10.50-12 • 27x9.50-12

STARCO prekės ženklų žymimas kameras gamina Pietų Korėjos korporacija NEXEN. Kameros gaminamos iš butilkaučiuko. Palyginti su natūralaus kaučiuko guma, butilkaučiukas pasižymi šiais privalumais:

- dideliu nepralaidumu dujoms ir dujų izoliacija
- dideliu atsparumu rūgštims, naftos produktams, karštam garui ir aukštai temperatūrai
- dideliu atsparumu ozonui, sukeliančiam gumos senėjimą
- išlieka lankstus esant žemoms temperatūroms

Nepriklausomi bandymai patvirtina, kad palyginti su natūralaus kaučiuko nepralaidumo dujoms savybėmis, mūsų kamerų iš butilkaučiuko nepralaidumas dujoms yra 3-4 kartus didesnis.

Oro skvarbos poveikis slėgiui

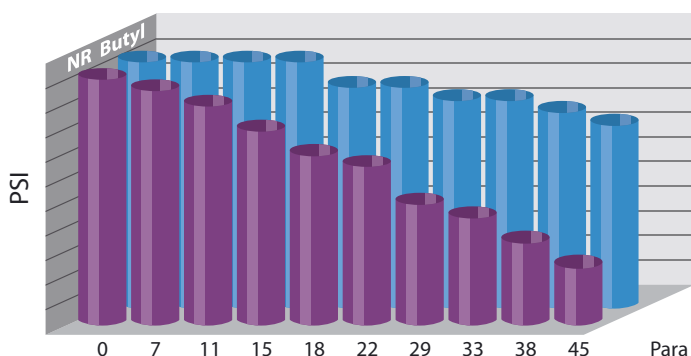

Palyginamasis natūralaus kaučiuko (NR) ir butilo kaučiuko (Butyl) gumos nusidėvėjimo bandymas

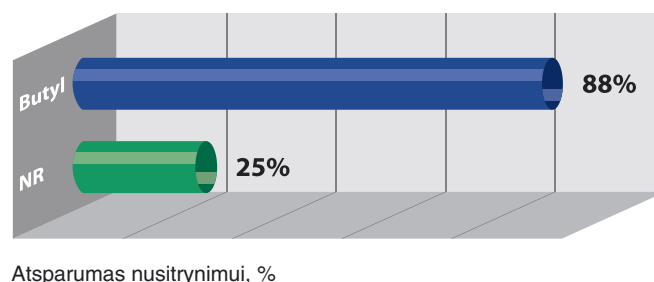

Atsparumas nusidėvėjimui, %

ExxonMob data



www.starco.com

 **UAB "STARCO"**

Savanorių pr. 180, Vilnius, LT-03154, Lietuva
Tel. +370 5 2332611; +370 5 2332355
Fax +370 5 2784809
e-mail: info@starco.lt
www.starco.lt

STARCO SMALL_TYRES/001/08.2014/LT



 **SIA "STARCO"**

"Lapegles" (Dommo Biznesa Parks),
Stūnīši, Olaines nov.,
LV-2127, Latvija
Tālrunis: +371 67 620 144
Fakss: +371 67 607 334
e-mail: starco@starco.lv
www.starco.lv

 **STARCO-E OÜ**

Turu tee 30, Järveküla küla,
Rae vald 75304 Harjumaa, Eesti
Tel. +372 65 000 21
Fax +372 65 000 57
e-mail: starco@starco.ee
www.starco.ee